

**Custom LED
Signs & Displays**

SP-001

- Frame Color :Silver
- Frame size:600*900mm or customized
- Rated voltage:Solar power, wide voltage 3-30V
- Material:Aluminum frame,Led, SEG fabric
- Thickness:125MM
- Side:Double/single side,outdoor
- temperature:9000K or customized
- Guarantee :1-2 years
- Usage:Shoping mall, store, cinema, restaurant,etc

Frame Size(mm)	Graphic Size(mm)	Visible Size(mm)	Weight	Light Power
600*600	600*600	597*597	6kgs	10w
600*800	600*800	597*797	7kgs	10w
600*900	600*900	597*897	8kgs	10w
800*1200	800*1200	797*1197	11kgs	25w



SP-002

- Solar Powered and rechargeable with batteries.
- Standard size or Custom sizes
- LED edge lit, SEG light box sign
- Double side with standing base
- LED lights, cables, adapters all CE and UL listed.

Frame Size	Battery	Solar Panel	Work Hours	Package for the Base	Package for the Light Box
600x1200mm 23.62x47.24"	36AH	100W	All night long	1020x170x720mm	660x170x1360mm
600x1600mm 23.62x62.99"	54AH	132W	All night long	1020x170x720mm	660x170x1760mm
800x1800mm 31.50x70.86"	54AH	154W	All night long	1020x170x920mm	860x170x1960mm
1000x2000mm 39.37x78.74"	72AH	186W	All night long	1020x170x1020mm	1060x170x2160mm
1200x2400mm 47.24x94.48"	72AH	200W	All night long	1020x170x1120mm	1260x170x2360mm



ALUMINIUM SNAP FRAME LED LIGHT BOX

- Ultra-thin
- Aluminum frame
- High brightness

- Outdoor
- Indoor
- Single sided
- Double sided

- 1525
- 1825
- 2130
- 2235

- 2230
- 2517
- 2840

Applications

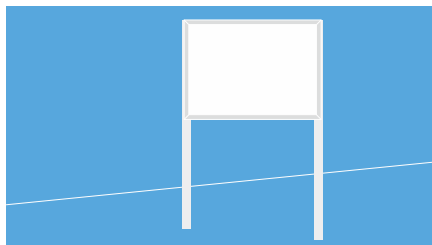

OUT DOOR

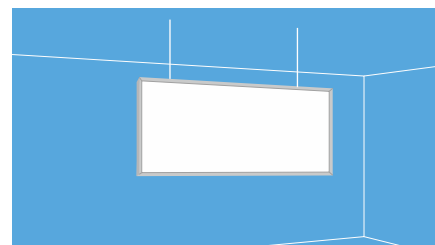

CEILING MOUNT

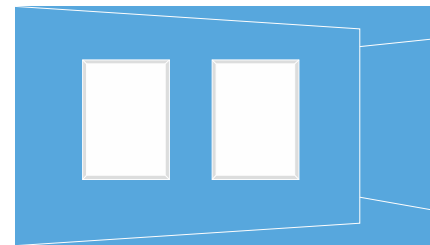

WALL MOUNT

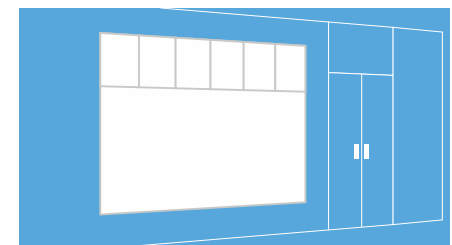

INLAY

1525

- Single side
- Frame: 15mm thickness
- Application: indoor

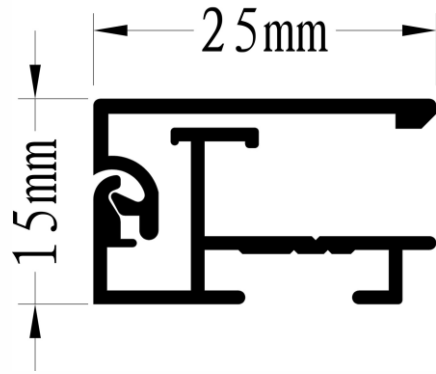

1825

- Single side
- Frame: 18mm thickness
- Application: indoor

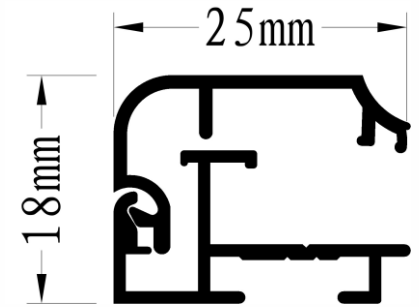

2130

- Single side
- Frame:21mm thickness
- Application:indoor

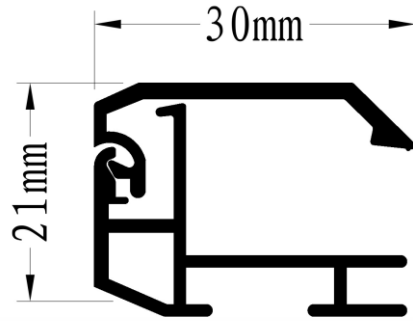

2230

- Double side
- Frame:22mm thickness
- Application:indoor

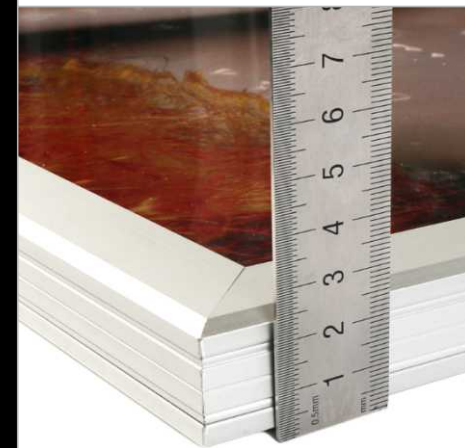
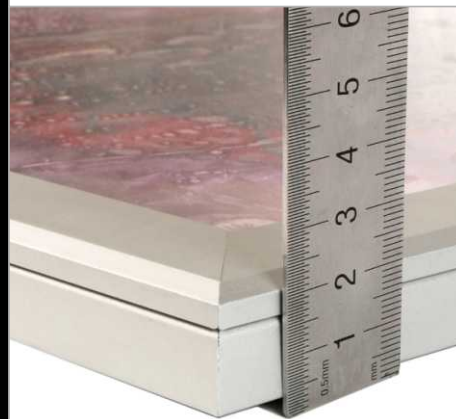
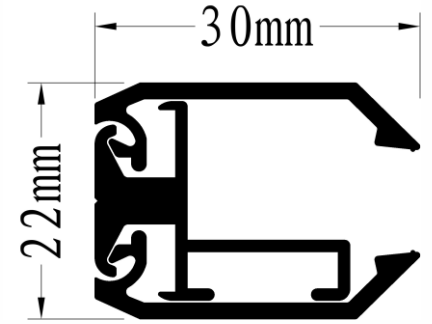

2235

- Single side
- Frame:22mm thickness
- Application:indoor

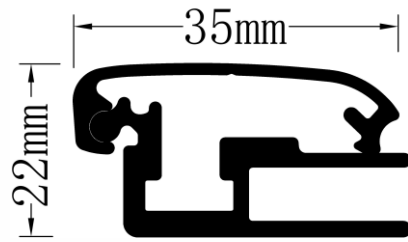

2228

- Magnetic
- Single side
- Frame:22mm thickness
- Application:indoor

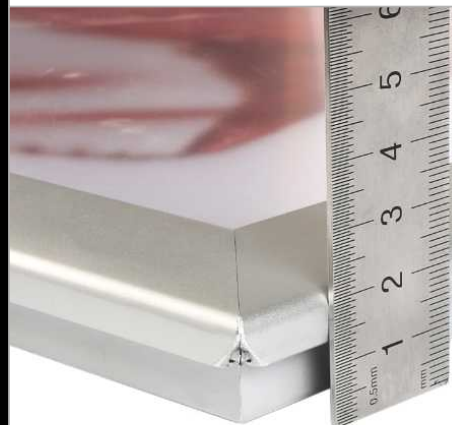
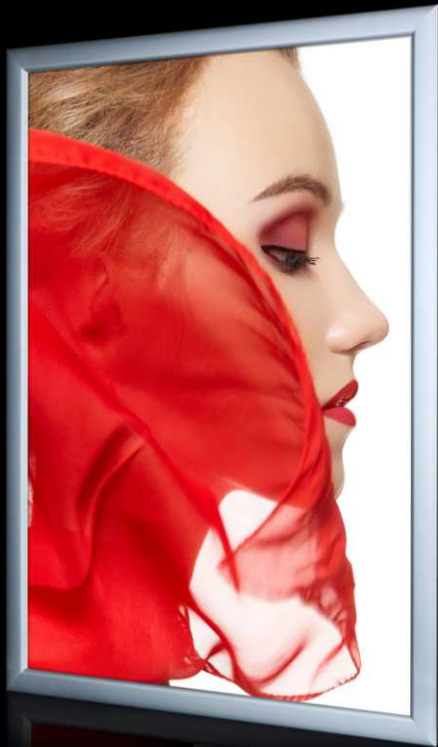
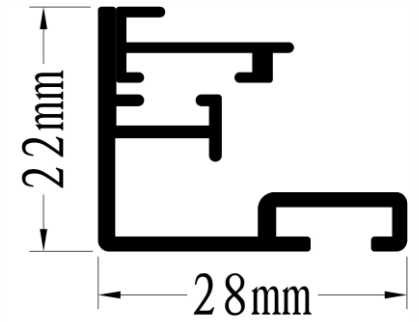

2517

- Single side
- Frame:25mm thickness
- Application:indoor

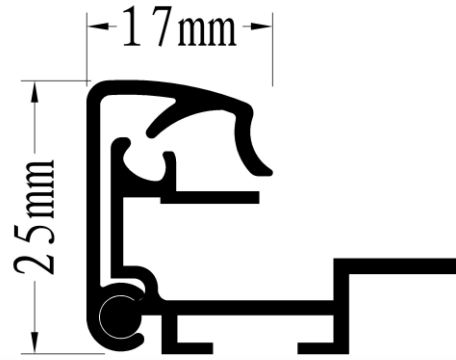

2840

- Single side
- Frame:28mm thickness
- Application:indoor

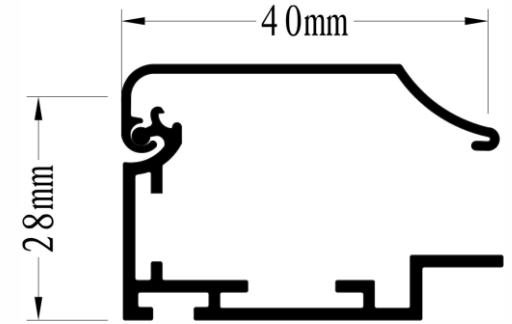



FRAMELESS FABRIC LED LIGHT BOX

- No frame
- Backlit led lights
- No dark areas
- Custom sizes
- Outdoor
- Indoor
- Single sided
- Double sided
- 3040
- 3240
- 4537
- 5030
- 6030
- 6037
- 8025
- 9640
- 8012
- 8016
- 10018

Applications

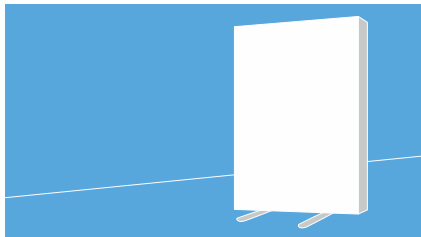

FREE STANDING

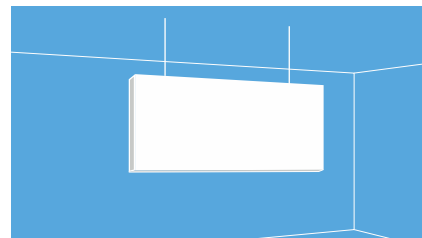

CEILING MOUNT



WALL MOUNT

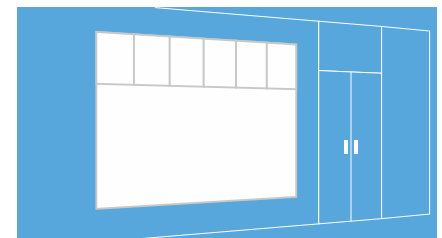

INLAY

3040

- Single side
- Frame:30mm thickness
- Application:indoor

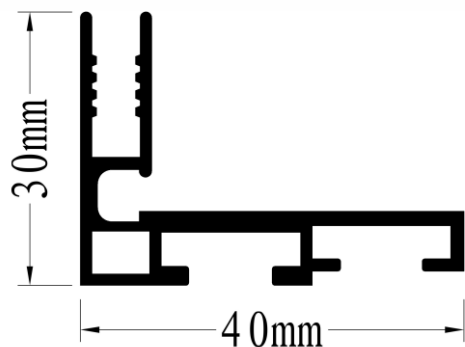

3240

- Single side
- Frame:32mm thickness
- Application:indoor

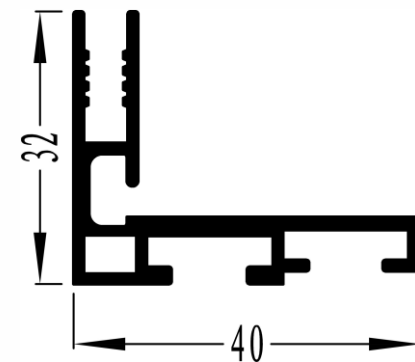

4537

- Single side
- Frame:45mm thickness
- Application:indoor

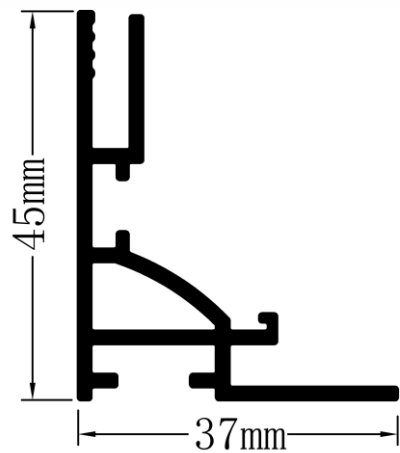

5030

- Single side
- Frame:50mm thickness
- Application:indoor

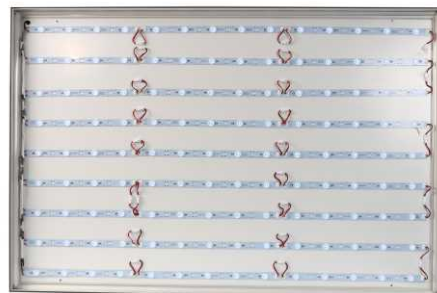
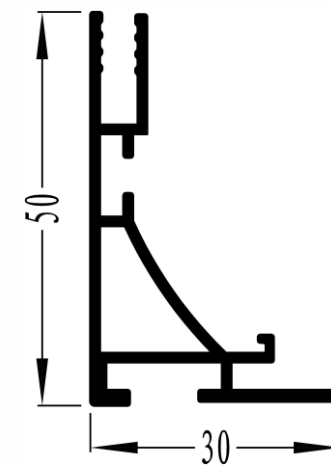

6030

- Single side
- Frame:60mm thickness
- Application:indoor

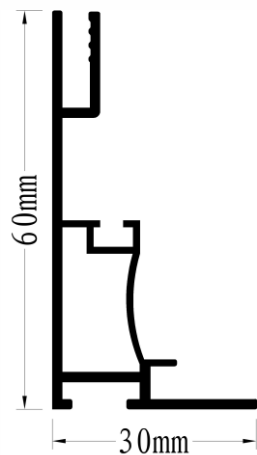

6037

- Single side
- Frame:60mm thickness
- Application:indoor

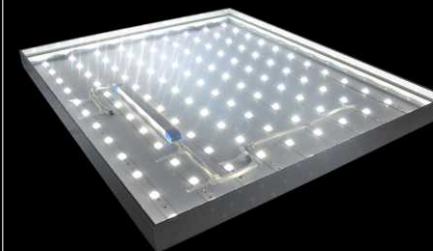
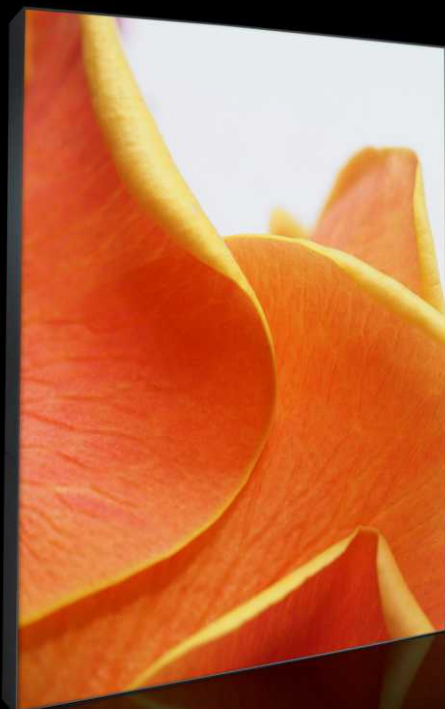
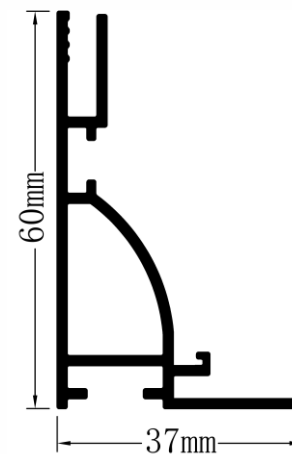

8025

- Single side
- Frame:80mm thickness
- Application:indoor

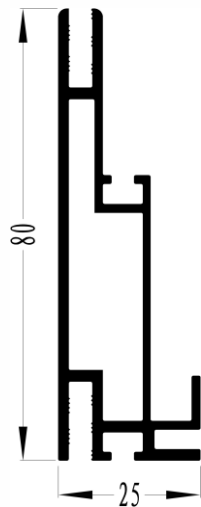

9640

- Single side
- Frame:96mm thickness
- Application:indoor

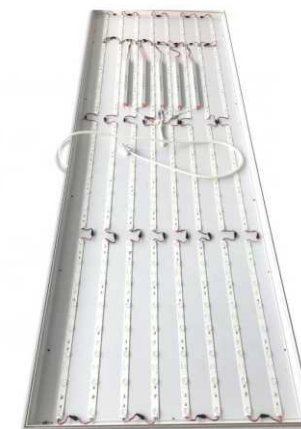
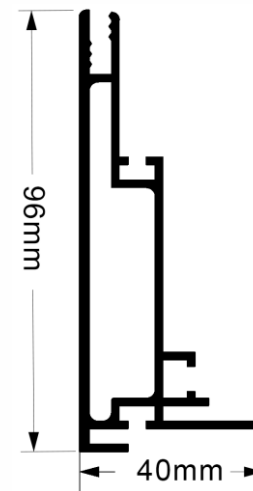

8012

- Double side
- Frame:80mm thickness
- Application:indoor/outdoor

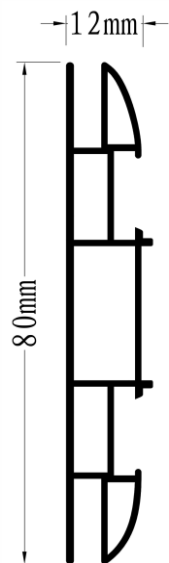

8016

- Double side
- Frame:80mm thickness
- Application:indoor

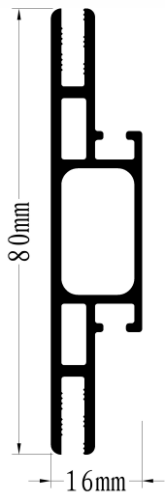

10018

- Double side
- Frame:100mm thickness
- Application:indoor

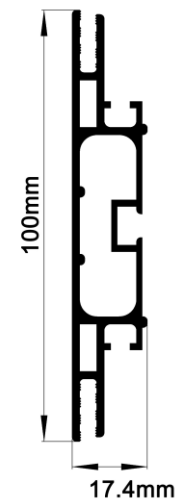



LED panel for display rack

- Silver aluminum frame
 - Cosmetic display rack
 - Super slim
- Indoor
 - Single sided
 - Double sided
- 0916
 - 1216
 - 1003
 - 1414
 - 1916
 - 0808

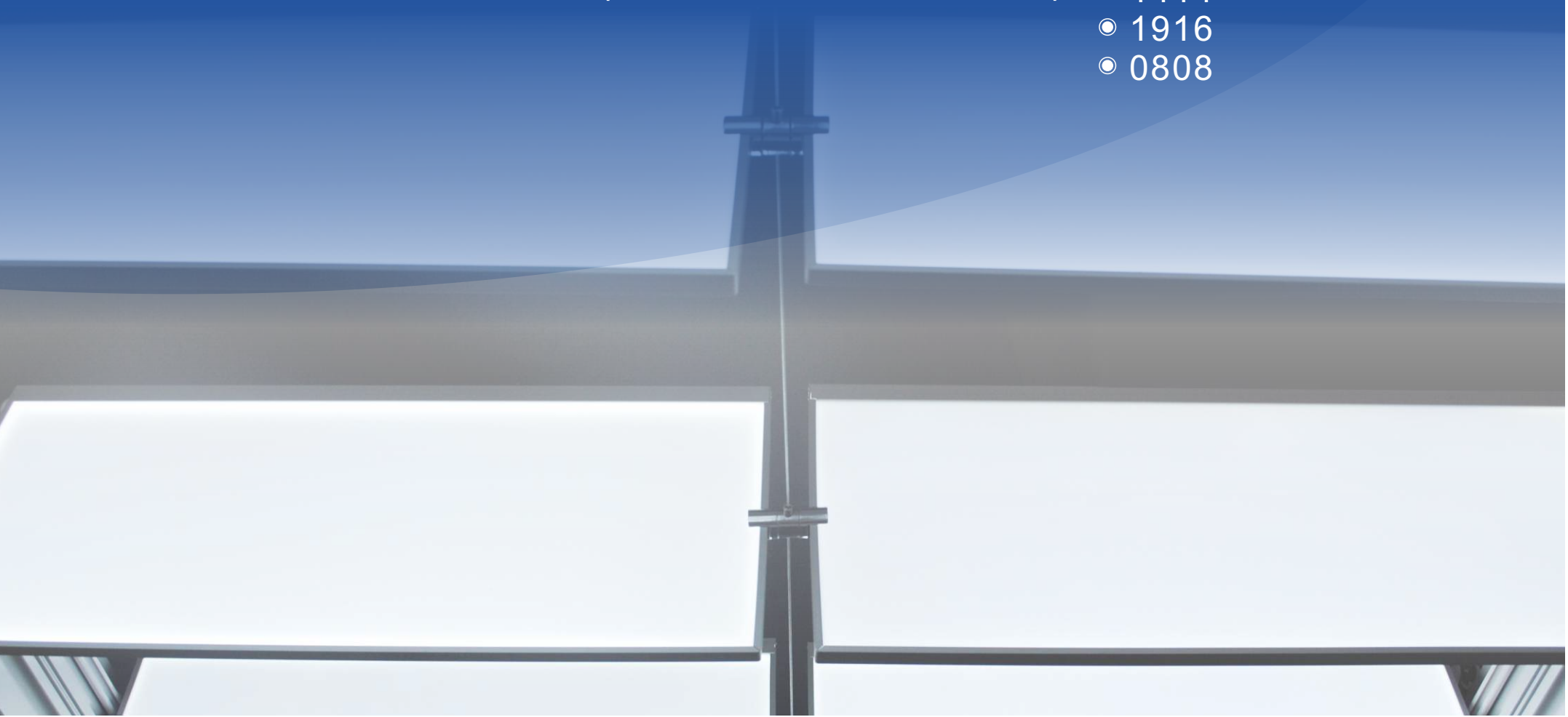

0916

- Single side
- Frame:9mm thickness
- Application:retail display rack led shelf light led panel

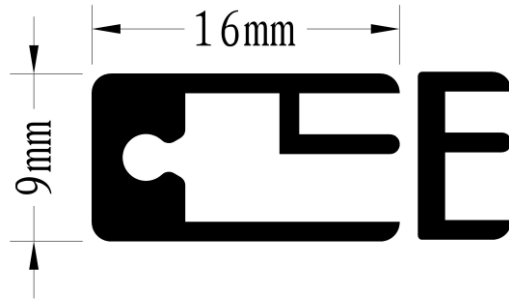

1216

- Double side
- Frame:12mm thickness
- Application:retail display rack led shelf light led panel

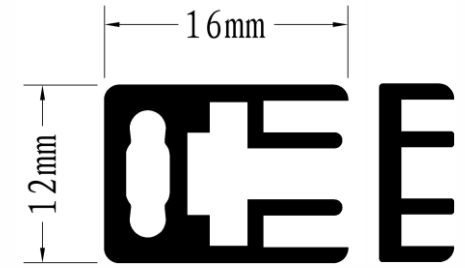

1003

- Single side
- Frame:10mm thickness
- Application:retail display rack led shelf light led panel

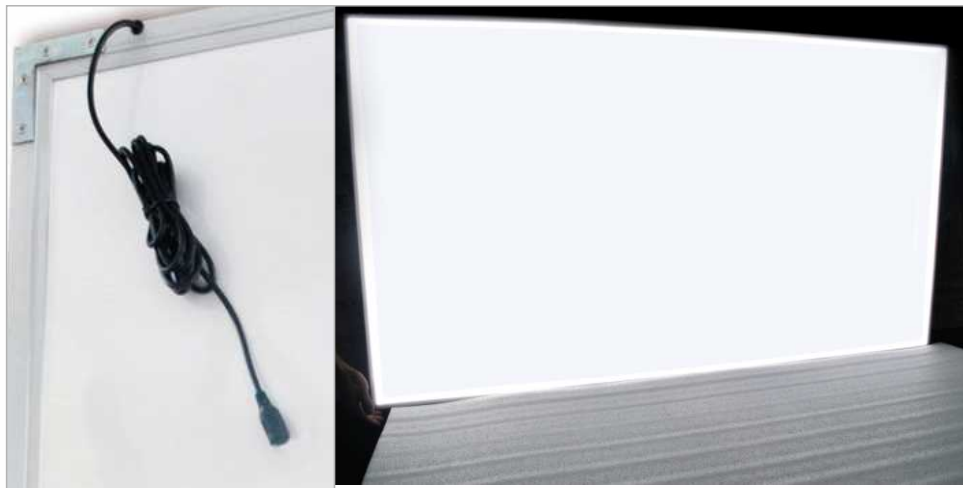
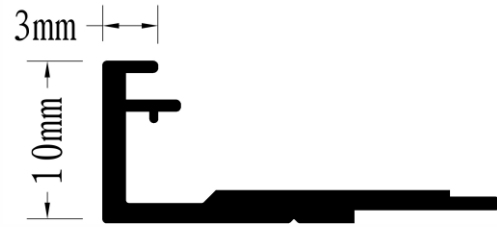

1414

- Double side
- Frame:14mm thickness
- Application:retail display rack led shelf light led panel

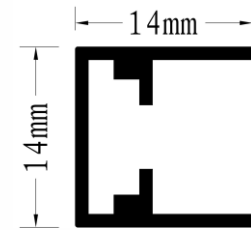

1916

- Single side/Double side
- Frame:19mm thickness
- Application:retail display rack led shelf light led panel

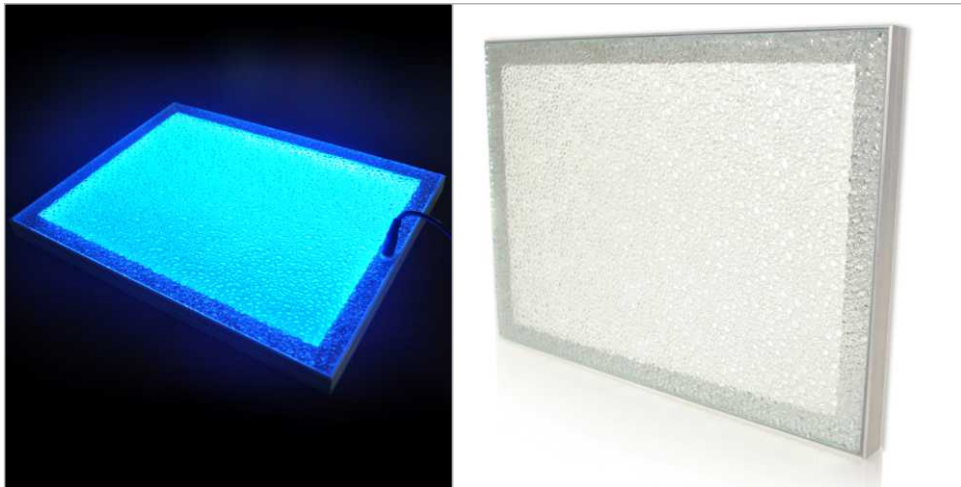
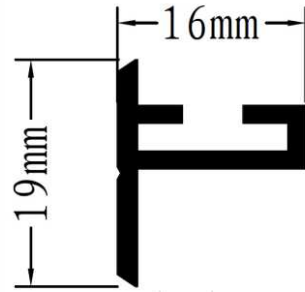

0808

LIGHTING PANEL FOR STORE FIXTURES

- Singleside/Double side
- light source : SMD 2835 Flexible LED Strip
- Power Supply: 110V-240V AC
- Edge wrap with white tape

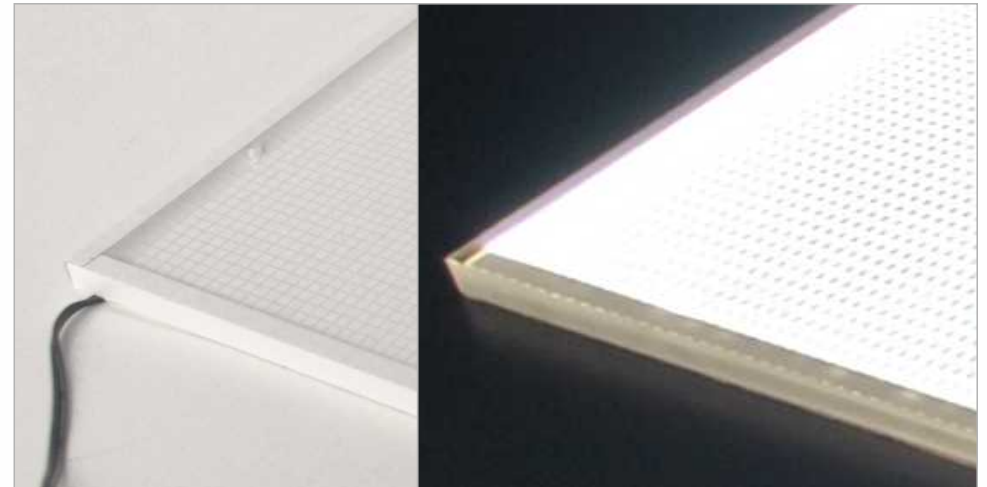

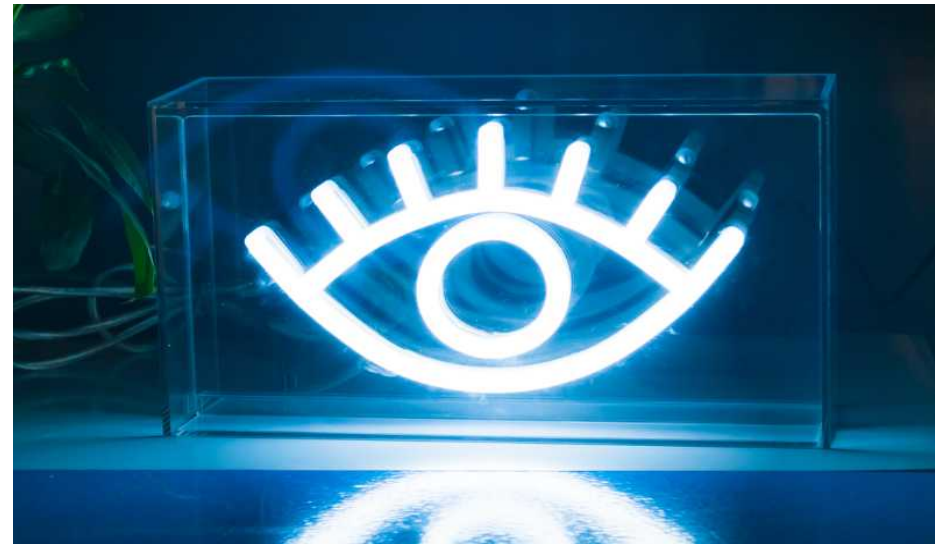



Crystal LED Light Box

- Acrylic light guide
- Windows display
- Light uniformity
- Free standing

- Outdoor
- Indoor
- Single sided
- Double sided

- CSA-1
- CSA-2
- CSA-3
- CSA-4

- CSB-3
- CSB-4
- CSB-5
- CSB-6
- CSB-7

- CSB-8
- CSB-9
- CSB-10
- CSB-11
- CSB-12

Applications

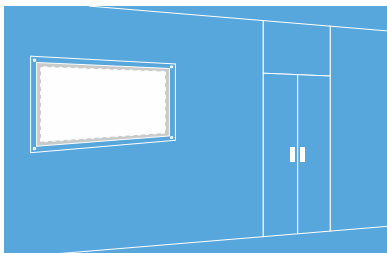

WALL MOUNT

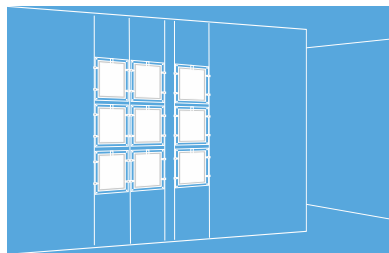

HANGING DISPLAY

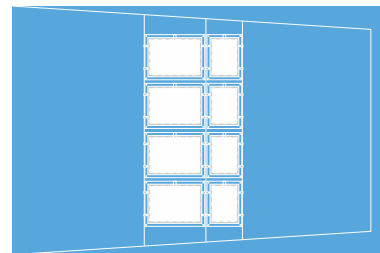

WINDOWS DISPLAY

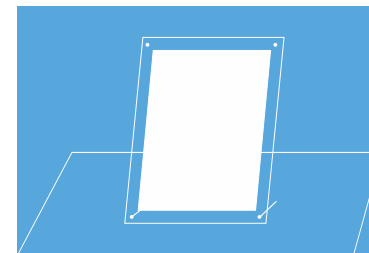

DESKTOP DISPLAY

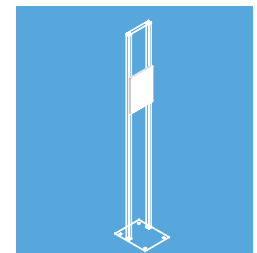

FREE STANDING

CSA-1

- Single side
- Material: acrylic
- Thickness: 10mm
- Application: Wall mounted



CSA-2

- Single side
- Material: acrylic
- Thickness: 10mm
- Application: desktop advertising



CSA-3

- Single side
- Magnetic
- Material: acrylic
- Thickness: 10mm
- Application: desktop advertising



CSA-4

- Single side
- Material: acrylic
- Thickness: 10mm
- Application: Wall mounted



CSB-3

- Single side/double side
- Magnetic
- Thickness:10mm
- Application: Window hanging display



CSB-4

- Single side/double side
- Magnetic
- Thickness:10mm
- Application: Window hanging display



CSB-5

- Single side/double side
- Thickness:10mm
- Application: Window hanging display

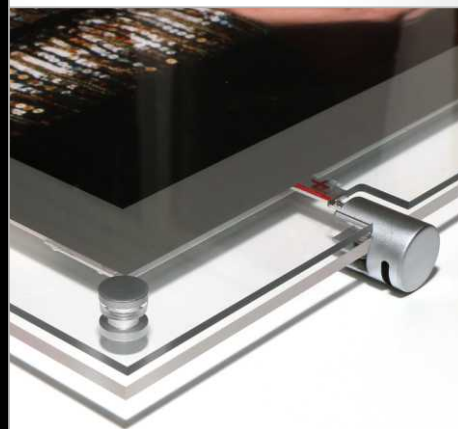

CSB-6

- Single side/double side
- Magnetic
- Thickness:10mm
- Application: Window hanging display



CSB-7

- Single side/double side
- Thickness:10mm
- Application: Window hanging display



CSB-8

- Single side/double side
- Magnetic
- Thickness:10mm
- Application: Window hanging display



CSB-9

- Single side/double side
- Thickness:10mm
- Application: Window hanging display



CSB-10

- Single side/double side
- Magnetic
- Thickness:10mm
- Application: Window hanging display

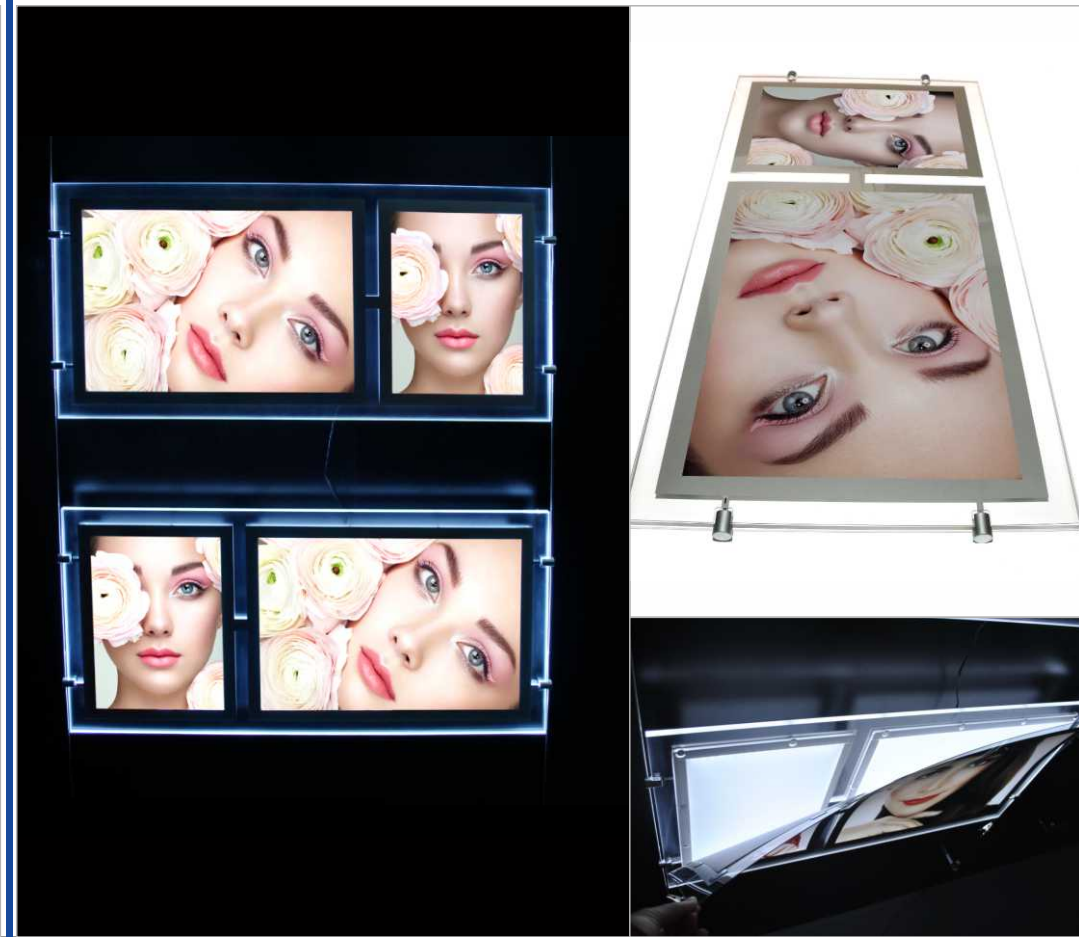

CSB-11

- Single side
- Magnetic
- Thickness:10mm
- Application: Free standing



CSB-12

- Single side
- Magnetic
- Thickness:10mm
- Application: desktop advertising



FITTING

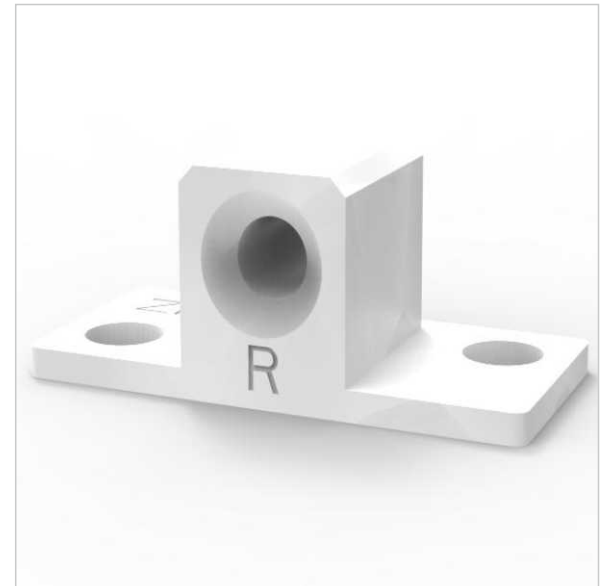



Custom LED Signs & Displays

info@lehitech.com
www.lehitech.com